

# Ventilation Fundamentals

DAY IN. DAY OUT.™

**Dayton**®



Available exclusively at **GRAINGER**®  
FOR THE ONES WHO GET IT DONE

# Ventilation Fundamentals

## Table of Contents

|   |         |
|---|---------|
| <b>Introduction to Fan Selection</b>            | Page 3  |
| Terms & Tech Data                               |         |
| Centrifugal Blowers                             |         |
| Propeller Fans and Duct Fans                    |         |
| Reading Performance Charts                      | Page 4  |
| Cross Reference Chart                           | Page 6  |
| <b>Fan Selection Based on Fan Application</b>   | Page 7  |
| General Commercial Ventilation                  | Page 8  |
| Commercial Kitchen Ventilation                  | Page 10 |
| General Industrial Ventilation                  | Page 12 |
| Determining CFM                                 | Page 14 |
| Determining Static Pressure                     | Page 15 |
| Preliminary Selections/Stability Considerations | Page 16 |
| Sound Levels/Motor Horsepower                   | Page 17 |
| Installation                                    | Page 18 |
| <b>Fan Performance</b>                          | Page 19 |
| Fan Dynamics and System Dynamics                |         |
| <b>Safety Practices</b>                         | Page 23 |
| <b>Basic Fan Laws</b>                           | Page 24 |

Call or stop by your branch, or go online to [granger.com/dayton](http://granger.com/dayton)

# Introduction to Fan Selection

## Terms & Tech Data HVAC Terminology

**AMCA (Air Movement and Control Association, Inc.)**—A nationally recognized association that establishes standards, tests and certifies the performance of air moving devices.

**A-Weighted** — A term which refers to the single number logarithmic summation of the 8 octave bands that have been adjusted to account for response of the human ear to sound pressure level.

**BHP (Brake Horsepower)** — Fan horsepower required.

**Btu (British Thermal Unit)** — The amount of energy or heat required to raise the temperature of one pound of water one degree Fahrenheit.

**BtuH** — One Btu per hour.

**CFM (Cubic Feet Per Minute)** — A measure of volume flow rate, or air moving capability, of an air moving device. Volume of air moved per minute.

**dB (Decibel)** — A measure of the sound produced by an air moving device.

**dB(A)** — Sound level reading on the A-weighted scale of a sound meter. This A-weighting adjusts response of the meter to approximate that of the human ear.

**Free Air Delivery** — The conditions existing when there are no effective restrictions to air flow (no static pressure) at the inlet or outlet of an air moving device.

**HP (Horsepower)** — The power required to drive an air moving device. HP required varies with system conditions.

**LwA** — A value representing the logarithmic summation of all 8 octave band values, adjusted to represent the effect of the "A" weighted network. This single number rating provides a useful number for comparison.

**Octave Bands**—The range of sound frequency that can be heard is divided into 8 octave bands.

**Plenum Chamber** — An air compartment maintained under pressure to serve one or more distributing ducts.

**RPM (Revolutions Per Minute)**—Speed at which the shaft of an air moving device is rotating.

**Sone** — An internationally recognized unit of loudness. Sones signify, in a single number, the total sound output of the unit being tested. One sone is approximately equal to the sound of a modern refrigerator in a kitchen. A 3-sone fan, for example, sounds twice as quiet to the human ear as a 6-sone fan.

**Sound Power Level** — The acoustic power radiating from a sound source, expressed in decibels.

**SP (Static Pressure)** — A measure of the resistance to movement of forced air through a system or installation, caused by ductwork, inlets, louvers, etc. Measured in inches of water gage (W.G.); the height, in inches, to which the pressure will lift a column of water. For a given system, static pressure varies as the square of the flow rate. Thus, if flow rate is doubled, system resistance or static pressure is increased four times.

**TS (Tip Speed)** — The speed of the tip of a fan wheel or prop measured in feet per minute.

**Venturi** — The formed inlet of a fan used to direct laminar airflow into the fan to improve performance.

## Propeller Fans and Duct Fans

**Propeller Fan (Axial Fan)**—An air moving device in which the air flow is parallel or axial to the shaft on which the propeller is mounted. These fans have good efficiency near free air delivery and are used primarily in low static pressure, high volume applications. As SP is increased, HP increases and CFM decreases. Usually mounted in a venturi, ring, or other housing featuring simple construction and low cost.

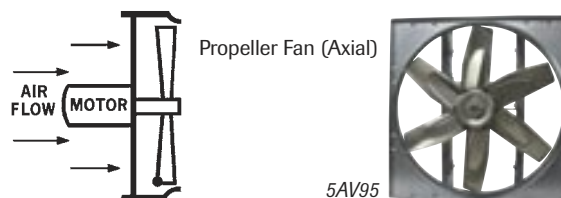

**Duct Fan (Tubeaxial)**—An air moving device in which the air flow is parallel or axial to the shaft on which the propeller is mounted. The propeller is housed in a cylindrical tube or duct. This design enables duct fans to operate at higher static pressures than propeller fans. Commonly used in spray booth and other ducted exhaust systems. As SP is increased, HP increases and CFM decreases.

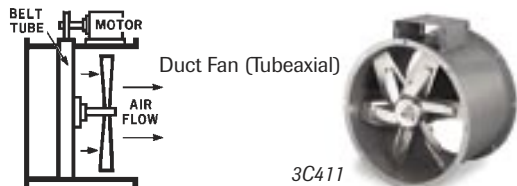

## Centrifugal Blower

Centrifugal blowers are air moving devices in which the air flow is perpendicular to the shaft on which the wheel is mounted. The wheel is mounted in a scroll-type housing, which is necessary to develop rated pressures. The four classes of centrifugal blowers are determined by wheel blade position with respect to the direction of rotation. As SP is increased, HP and CFM decrease.

### Forward Curve (FC)

The tips of the blades are inclined in the direction of rotation; the most common type of centrifugal blower. Normally used in residential heating and air conditioning systems and light-duty exhaust systems where maximum air delivery and low noise levels are required. Capable of pressures up to approximately  $1\frac{1}{2}$ " SP.



### Backward Incline (BI)

The tips of the blades are inclined away from the direction of rotation. Used in commercial/industrial, heavy-duty heating/cooling systems that require heavy-duty construction, non-overloading characteristics and stable air delivery. These blowers operate at higher efficiencies than forward curved blowers. Not as quiet as forward curve blowers because they operate at higher speeds. Can be used in systems up to 3" static pressure. Smaller diameter wheels are supplied with flat blades; larger diameter wheels are supplied with air foil blades to improve efficiency.



### Radial Blade

Has straight blades that are, to a large extent, self-cleaning, making them suitable for various kinds of material handling and particle-and-grease-laden air. Wheels are of simple construction and have relatively narrow blades. They can withstand the high speeds required to operate at higher static pressures (up to 12") but usually are noisier than FC or BI blowers.

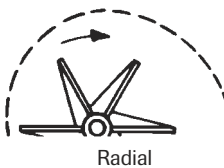

### Inline (Square Centrifugal Fan)

Air flow is developed as in a centrifugal blower, but after leaving the impeller the air is contained in a square housing and, by means of turning vanes, is discharged in an axial direction. Employs single-inlet centrifugal wheels, usually with backward inclined blades. The square centrifugal fan has performance characteristics similar to a centrifugal blower and the compact physical configuration of the tubeaxial fan. Can be vertically or horizontally mounted, thus providing a simpler installation by minimizing need for duct turns and transitions.

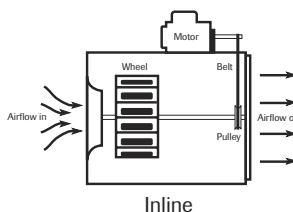

# Introduction to Fan Selection

## Reading Performance Charts

The most important part of selecting a fan is the ability to read the performance charts. Most of the performance charts in the catalog are similar and are read in the same manner. The selection procedure for direct drive and belt drive fans are slightly different.

**Belt Drive Selection** – Assume that a job requires a belt drive roof exhauster to move 2400 CFM against 0.25" SP. Refer to the performance model at the bottom of this page. Start at the top of the chart with the 0.25" SP column. (All numbers in this column correspond to 0.25" SP.) Now follow the column downward until a value is found that slightly exceeds 2400 CFM. In this case, 2710 is the first box that meets the performance requirements.

|              |             |
|--------------|-------------|
| <i>CFM</i>   |             |
| <i>Sones</i> | <i>Bhp</i>  |
| <i>2710</i>  |             |
| <i>17.4</i>  | <i>.737</i> |

At this performance point, the sone value is 17.4 and the fan Bhp required is 0.737. By following the row to the left, we can determine fan rpm and the fan stock number. In this case, the fan rpm is 1545 and the stock number is 7A557.

Notice that 7A557 is not the only model to choose from. If we follow the 0.250" SP column down further, we find a performance point of 2434 CFM. At this point, the sone value is 11.5 and the Bhp is 0.332. Following across to the left we find the rpm to be 945. The stock number for this fan is 7A559 with a 1/3 hp motor.

Both the 7A557 and the 7A559 will perform the air movement task equally as well. However, the sound generated by the fan may have to be considered. Compare the sone values: 17.4 sones for the 7A557 and 11.5 sones for the 7A559. The 7A559 is about 34% quieter. Where a low sound fan is required, the 7A559 would be a better selection. If loudness is not a factor, the 7A559 would be a better selection because it is less expensive.

Another factor to consider in fan selection is the dimension of the base (i.e. Curb cap size). Stock number 7A563 will also meet the air movement requirements with 2832 CFM at 0.250" SP. Although the list performance is over 400 CFM greater than desired, utilizing the variable pitch pulleys provided will allow the fan to meet the performance criteria. For example, if a particular application has a 28.5" curb installed, 7A563 will require no additional adapters as the fan base is 30". For this example, the 7A563 is the better selection as the total cost will be less.

Another possibility for this particular selection is the 7A556. At 1360 rpm, this fan will achieve 2347 CFM. Although this is slightly less than the desired 2400 CFM, at 0.25" SP was only an estimate. If 0.25" SP is believed to be an overestimate, then the 7A556 would meet the performance requirements.

An advantage of choosing the 7A557 over the 7A556 is that it is capable of running at higher rpm's, which enables the fan to move more air if necessary. As with all Dayton belt drive fans, intermediate CFM values are easily achieved by adjusting the motor pulley (see illustration). Motor pulleys are adjusted by loosening the set screw and turning the top half of the pulley (see illustration). This causes the pulley diameter to change, which results in changing the fan rpm.

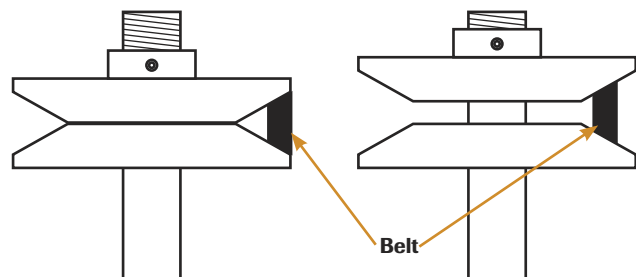

**Opening the Pulley decreases fan RPM. Closing the Pulley increases fan RPM.**

## Direct Drive Selection

Selection of direct drive fans (those with the motor shaft connected to the fan wheel or propeller) is nearly the same as belt drive selection. However, there are two differences worth noting. Where belt drive fan speed can be altered by adjusting the motor pulley, direct drive fans (since they have no pulleys) must use a different method.

To adjust a direct drive fan's speed (also motor speed) or to provide a means of meeting an exact performance requirements, a speed control can be furnished (except on 1725 rpm motors). Speed controls vary the voltage supplied to the fan and slows it down; a principle similar to the way dimmer light switches work.

## Accessories

Most fans are ordered with accessories. Here are some common accessories for selected models:

| Model   | Common Accessories             |
|---|--------------------------------|
| Downblast Exhaust Ventilators Centrifugal Direct Drive and Belt Drive | Roof Curb, Backdraft Damper    |
| Upblast Exhaust Ventilators Centrifugal Belt Drive                    | Roof Curb, Grease Container    |
| Sidewall Exhaust Supply   | Wall Mount Housing or Shutters |
| Cabinet and Ceiling Ventilators                                       | Speed Control, Discharge Vents |
| Inline Blowers  | Backdraft Damper               |

# Introduction to Fan Selection

| 4YU95        |     |      |      | Static Pressure in Inches W.G. |               |               |               |               |               |               |               |               |               |               |               |               |  |
|--------------|-----|------|------|--------------------------------|---------------|---------------|---------------|---------------|---------------|---------------|---------------|---------------|---------------|---------------|---------------|---------------|--|
|              |     |      |      | 0.000 CFM BHP                  | 0.125 CFM BHP | 0.250 CFM BHP | 0.375 CFM BHP | 0.500 CFM BHP | 0.625 CFM BHP | 0.750 CFM BHP | 0.875 CFM BHP | 1.000 CFM BHP | 1.250 CFM BHP | 1.500 CFM BHP | 1.750 CFM BHP | 2.000 CFM BHP |  |
| Stock Number | HP  | RPM  | TS   | Sones                          | Sones         | Sones         | Sones         | Sones         | Sones         | Sones         | Sones         | Sones         | Sones         | Sones         | Sones         | Sones         |  |
| 7A554        | 1/4 | 1075 | 4116 | 1994                           | 1882          | 1771          | 1647          | 1490          | 1266          |               |               |               |               |               |               |               |  |
|              |     |      |      | 0.238                          | 0.249         | 0.257         | 0.259         | 0.262         | 0.251         |               |               |               |               |               |               |               |  |
|              |     |      |      | 10.0                           | 9.9           | 9.4           | 8.9           | 8.4           | 7.8           |               |               |               |               |               |               |               |  |
| 7A555        | 1/3 | 1170 | 4480 | 2170                           | 2067          | 1966          | 1859          | 1734          | 1575          | 1356          |               |               |               |               |               |               |  |
|              |     |      |      | 0.307                          | 0.318         | 0.329         | 0.334         | 0.336         | 0.335         | 0.321         |               |               |               |               |               |               |  |
|              |     |      |      | 11.4                           | 11.3          | 10.8          | 10.3          | 9.9           | 9.3           | 8.7           |               |               |               |               |               |               |  |
| 7A556        | 1/2 | 1360 | 5207 | 2523                           | 2433          | 2347          | 2259          | 2166          | 2062          | 1943          | 1793          | 1602          |               |               |               |               |  |
|              |     |      |      | 0.482                          | 0.495         | 0.509         | 0.519         | 0.524         | 0.524         | 0.533         | 0.524         | 0.507         |               |               |               |               |  |
|              |     |      |      | 14.6                           | 14.3          | 13.9          | 13.5          | 13.1          | 12.7          | 12.2          | 11.6          | 11.0          |               |               |               |               |  |
| 7A557        | 3/4 | 1545 | 5916 | 2866                           | 2787          | 2710          | 2634          | 2556          | 2476          | 2384          | 2287          | 2177          | 1890          |               |               |               |  |
|              |     |      |      | 0.706                          | 0.722         | 0.737         | 0.752         | 0.762         | 0.769         | 0.769         | 0.773         | 0.782         | 0.752         |               |               |               |  |
|              |     |      |      | 17.6                           | 18.0          | 17.4          | 17.1          | 16.8          | 15.9          | 14.9          | 14.8          | 14.7          | 14.7          |               |               |               |  |
| 7A558        | 1   | 1705 | 6528 | 3163                           | 3091          | 3020          | 2952          | 2883          | 2811          | 2739          | 2657          | 2574          | 2370          | 2120          | 1731          |               |  |
|              |     |      |      | 0.949                          | 0.966         | 0.983         | 1.0           | 1.017         | 1.025         | 1.033         | 1.033         | 1.033         | 1.047         | 1.016         | 0.958         |               |  |
|              |     |      |      | 20                             | 20            | 20            | 19.6          | 19.2          | 18.9          | 18.1          | 17.3          | 16.9          | 16.7          | 16.6          | 16.4          |               |  |

| 4YU96        |     |      |      | Static Pressure in Inches W.G. |               |               |               |               |               |               |               |               |               |               |               |               |
|--------------|-----|------|------|--------------------------------|---------------|---------------|---------------|---------------|---------------|---------------|---------------|---------------|---------------|---------------|---------------|---------------|
|              |     |      |      | 0.000 CFM BHP                  | 0.125 CFM BHP | 0.250 CFM BHP | 0.375 CFM BHP | 0.500 CFM BHP | 0.625 CFM BHP | 0.750 CFM BHP | 0.875 CFM BHP | 1.000 CFM BHP | 1.250 CFM BHP | 1.500 CFM BHP | 1.750 CFM BHP | 2.000 CFM BHP |
| Stock Number | HP  | RPM  | TS   | Sones                          | Sones         | Sones         | Sones         | Sones         | Sones         | Sones         | Sones         | Sones         | Sones         | Sones         | Sones         | Sones         |
| 7A559        | 1/3 | 945  | 4113 | 2791                           | 2612          | 2434          | 2236          | 2010          | 1692          |               |               |               |               |               |               |               |
|              |     |      |      | 0.307                          | 0.321         | 0.332         | 0.338         | 0.337         | 0.32          |               |               |               |               |               |               |               |
|              |     |      |      | 12.6                           | 12.0          | 11.5          | 11.2          | 10.7          | 10.0          |               |               |               |               |               |               |               |
| 7A560        | 1/2 | 1100 | 4788 | 3249                           | 3095          | 2943          | 2787          | 2615          | 2429          | 2198          | 1900          |               |               |               |               |               |
|              |     |      |      | 0.485                          | 0.501         | 0.516         | 0.527         | 0.533         | 0.534         | 0.523         | 0.499         |               |               |               |               |               |
|              |     |      |      | 15.3                           | 14.7          | 14.1          | 13.8          | 13.5          | 13.0          | 12.5          | 12.0          |               |               |               |               |               |
| 7A561        | 3/4 | 1250 | 5441 | 3692                           | 3557          | 3422          | 3289          | 3149          | 2997          | 2838          | 2658          | 2444          |               |               |               |               |
|              |     |      |      | 0.711                          | 0.729         | 0.747         | 0.764         | 0.774         | 0.781         | 0.785         | 0.779         | 0.764         |               |               |               |               |
|              |     |      |      | 17.9                           | 17.4          | 17.0          | 16.6          | 16.3          | 16.0          | 15.6          | 15.2          | 14.9          |               |               |               |               |
| 7A562        | 1   | 1375 | 5985 | 4062                           | 3938          | 3815          | 3694          | 3571          | 3444          | 3304          | 3161          | 3007          | 2609          | 2073          |               |               |
|              |     |      |      | 0.947                          | 0.967         | 0.987         | 1.005         | 1.021         | 1.033         | 1.04          | 1.045         | 1.042         | 1.006         | 0.93          |               |               |
|              |     |      |      | 21                             | 20            | 19.6          | 19.2          | 18.9          | 18.6          | 18.4          | 18.0          | 17.6          | 17.2          | 15.4          |               |               |

| 4YU97        |       |      |      | Static Pressure in Inches W.G. |               |               |               |               |               |               |               |               |               |               |               |               |    |
|--------------|-------|------|------|--------------------------------|---------------|---------------|---------------|---------------|---------------|---------------|---------------|---------------|---------------|---------------|---------------|---------------|----|
|              |       |      |      | 0.000 CFM BHP                  | 0.125 CFM BHP | 0.250 CFM BHP | 0.375 CFM BHP | 0.500 CFM BHP | 0.625 CFM BHP | 0.750 CFM BHP | 0.875 CFM BHP | 1.000 CFM BHP | 1.250 CFM BHP | 1.500 CFM BHP | 1.750 CFM BHP | 2.000 CFM BHP |    |
| Stock Number | HP    | RPM  | TS   | Sones                          | Sones         | Sones         | Sones         | Sones         | Sones         | Sones         | Sones         | Sones         | Sones         | Sones         | Sones         | Sones         |    |
| 7A563        | 1/3   | 810  | 3923 | 3150                           | 2997          | 2832          | 2624          | 2375          | 2053          |               |               |               |               |               |               |               |    |
|              |       |      |      | 0.292                          | 0.306         | 0.332         | 0.345         | 0.35          | 0.342         |               |               |               |               |               |               |               |    |
|              |       |      |      | 8.8                            | 9.9           | 8.7           | 8.4           | 8.2           | 7.5           |               |               |               |               |               |               |               |    |
| 7A564        | 1/2   | 940  | 4553 | 3655                           | 3527          | 3388          | 3234          | 3052          | 2844          | 2601          | 2272          |               |               |               |               |               |    |
|              |       |      |      | 0.456                          | 0.474         | 0.494         | 0.522         | 0.539         | 0.547         | 0.544         | 0.525         |               |               |               |               |               |    |
|              |       |      |      | 12.7                           | 12.8          | 12.0          | 11.4          | 11.1          | 10.6          | 10.3          | 9.8           |               |               |               |               |               |    |
| 7A565        | 3/4   | 1055 | 5110 | 4102                           | 3990          | 3867          | 3742          | 3596          | 3432          | 3252          | 3050          | 2811          |               |               |               |               |    |
|              |       |      |      | 0.645                          | 0.666         | 0.68          | 0.721         | 0.74          | 0.761         | 0.774         | 0.774         | 0.766         |               |               |               |               |    |
|              |       |      |      | 16.2                           | 15.7          | 14.9          | 14.4          | 14.0          | 13.5          | 12.9          | 12.7          | 12.4          |               |               |               |               |    |
| 7A566        | 1     | 1185 | 5739 | 4608                           | 4508          | 4401          | 4290          | 4179          | 4046          | 3900          | 3753          | 3575          | 3178          | 2499          |               |               |    |
|              |       |      |      | 0.914                          | 0.938         | 0.956         | 0.981         | 1.032         | 1.048         | 1.071         | 1.096         | 1.097         | 1.086         | 0.991         |               |               |    |
|              |       |      |      | 19.0                           | 18.4          | 17.8          | 17.4          | 17.1          | 16.7          | 16.2          | 15.8          | 15.4          | 14.7          | 13.7          |               |               |    |
| 7A567        | 1 1/2 | 1335 | 6466 | 5191                           | 5102          | 5010          | 4913          | 4814          | 4716          | 4599          | 4475          | 4344          | 4052          | 3713          | 3262          |               |    |
|              |       |      |      | 1.307                          | 1.334         | 1.358         | 1.374         | 1.414         | 1.471         | 1.493         | 1.513         | 1.542         | 1.568         | 1.56          | 1.51          |               |    |
|              |       |      |      | 22                             | 22            | 21            | 21            | 21            | 20            | 19.9          | 19.5          | 19.2          | 18.7          | 18.2          | 17.6          |               |    |
| 7A660        | 2     | 1460 | 7071 | 5677                           | 5596          | 5514          | 5425          | 5336          | 5246          | 5155          | 5049          | 4938          | 4699          | 4426          | 4123          | 3765          |    |
|              |       |      |      | 1.71                           | 1.739         | 1.768         | 1.787         | 1.805         | 1.863         | 1.926         | 1.951         | 1.968         | 2.03          | 2.051         | 2.046         | 2.018         |    |
|              |       |      |      | 26                             | 25            | 24            | 24            | 24            | 24            | 23            | 23            | 23            | 22            | 22            | 22            | 22            | 21 |

# Cross Reference Chart

| Dayton Fan Description   | Acme           | AirMaster<br>(Chelsea) | Captive<br>Aire<br>(Flow Air) | Carnes        | COOLAIR<br>(ILG)   | Greenheck          | Jenn<br>(Breidert)<br>(Stanley) | Loren Cook         | Penn Barry      |
|--|----------------|------------------------|-------------------------------|---------------|--------------------|--------------------|---------------------------------|--------------------|-----------------|
| <b>Cabinet &amp; Ceiling Ventilators</b>                                   | VQ/VQL         | NCF                    | CFA                           | VCDB,<br>VCDC | CF                 | SP                 | J, EC, L                        | GC                 | Zephyr          |
| <b>Inline Ventilators</b>  | VQ/VQL         | DCF                    | n/a                           | VCDB          | IL                 | CSP                | n/a                             | Gemini<br>Inline   | Zephyr          |
| <b>Sidewall Propeller Fans -<br/>Direct-Drive</b>                          | FQ             | EPR                    | C-EPR                         | LYDK,<br>LZDK | UDU/UDF            | SE/SS              | GDW                             | SWD                | P               |
| <b>Sidewall Hazardous Propeller Fans -<br/>Direct-Drive</b>                | DCK, K         | HA                     | n/a                           | LRBA,<br>LNBA | CBC                | SBCE/SBCS          | HBW                             | AWB                | BC, BAT         |
| <b>Aluminum Propeller Fans -<br/>Direct-Drive</b>                          | FN             | HV, HVE                | n/a                           | LRDA,<br>LNDA | CDC                | SCE/SCS            | n/a                             | AWD                | BC              |
| <b>Sidewall Propeller Fans -<br/>Belt-Drive</b>                            | DC             | HA                     | CPB                           | LWBK,<br>LMBK | CBL, CBH           | SBE/SBS            | TBW                             | XLW,<br>XMW        | BBK, BFL        |
| <b>Heavy Duty Propeller Fans -<br/>Direct-Drive</b>                        | DCH            | n/a                    | n/a                           | LJDB,<br>LKDB | CBHX               | SBE/SBS-3          | LBW                             | XLWH,<br>XMWH      | BF              |
| <b>Filtered Supply Fans -<br/>Centrifugal Belt-Drive</b>                   | AFSI           | CAS                    | n/a                           | n/a           | n/a                | SAF, KSF,<br>KSF-B | n/a                             | KSPB,<br>KSPD      | FHS Muffan      |
| <b>Upblast Exhaust Ventilators -<br/>Centrifugal Direct-Drive</b>          | PDU            | n/a                    | DU                            | VUDK          | CUD, UBD           | CUE                | n/a                             | ACRUD,<br>VCRD     | Fumex FX        |
| <b>Sidewall Exhaust Ventilators -<br/>Centrifugal Direct-Drive</b>         | PDU-W          | CDU                    | DU                            | VWDK          | CWD                | CW                 | CWD                             | ACWD               | Fumex WFX       |
| <b>Upblast Exhaust Ventilators -<br/>Centrifugal Belt-Drive</b>            | PNU            | CBU                    | NCA                           | VUBK,<br>VRBK | UBC, CUB           | CUBE               | NBTD                            | ACRUB,<br>VCR      | Fumex FXB       |
| <b>Downblast Exhaust &amp; Supply Ventilators -<br/>Axial Direct-Drive</b> | LQ             | XRE                    | DDAR                          | LESA          | n/a                | AE/AS              | ARS                             | AQD                | DAS             |
| <b>Downblast Exhaust Ventilators -<br/>Axial Belt-Drive</b>                | n/a            | n/a                    | n/a                           | n/a           | n/a                | ABE                | n/a                             | SEP, AQB           | n/a             |
| <b>Downblast Exhaust Ventilators -<br/>Centrifugal Direct-Drive</b>        | PRN            | CDD                    | DR                            | VEDK          | CRD                | G                  | CRD                             | ACED               | Domex DX        |
| <b>Downblast Exhaust Ventilators -<br/>Centrifugal Belt-Drive</b>          | PN, PNN,<br>PV | CBD                    | DD                            | VEBK          | CRB                | GB                 | NBCR                            | ACEB               | Domex DXB       |
| <b>Hooded Roof Fans -<br/>Axial Belt-Drive</b>                             | EC, EC-S       | n/a                    | n/a                           | LTBA,<br>LGBA | PB                 | RBE, RBS           | n/a                             | HSE,<br>HSS        | AF              |
| <b>Hooded In-Take &amp; Release Ventilators</b>                            | EV/IV          | RRL                    | n/a                           | GI/GE         | TEV/TIV            | FHI/FHR            | RVA/RVG                         | VR/VI              | AIRETTE         |
| <b>Upblast Exhaust Ventilators -<br/>Axial Belt-Drive</b>                  | UBG            | UPB                    | CUPB                          | LUBA          | JBH, JBC<br>(cast) | RBU                | BRU                             | LEU, LXUL,<br>LXUM | HF, HS          |
| <b>Inline Duct Blowers -<br/>Back Inclined</b>                             | XB             | SBCL                   | CVIBK                         | VIBK          | SQBA               | BSQ                | ILB                             | SQIB,<br>SQNB      | Centrex         |
| <b>Inline Duct Blowers &amp; Filters -<br/>Forward Curve</b>               | DM             | n/a                    | n/a                           | n/a           | n/a                | BDF                | n/a                             | DB, SDB,<br>DBX    | Zephyr ZC       |
| <b>Forward Curve Blowers</b>   | FCE            | UDF                    | n/a                           | n/a           | n/a                | SFD                | FCD                             | CPFD               | n/a             |
| <b>Forward Curve<br/>Belt-Drive Blowers</b>                                | FCF, FCD       | UXF                    | n/a                           | VFBA          | VSFC               | SFB                | FCB                             | CPFB               | n/a             |
| <b>High Pressure Radial Blade<br/>Belt-Drive Blowers</b>                   | 400 MB         | n/a                    | n/a                           | n/a           | n/a                | IPW                | n/a                             | MH(B)              | n/a             |
| <b>Backward Incline<br/>Belt-Drive Blowers</b>                             | QBR            | UXB                    | BI                            | VBBA          | VSBC               | SWB                | JVS                             | CPV, CPS           | Dynamo D,<br>QX |



# Fan Selection Based On Fan Application

## Basic Overview

Ventilating a building simply replaces stale or foul air with clean, fresh air. Although the ventilation process is required for many different applications, the airflow fundamentals never change:

Undesired air out, fresh air in

The key variables that do change depending on applications are the fan model and the air volume flow rate (CFM). Other considerations include the resistance to airflow (static pressure or SP) and sound produced by the fan (Sones).

Occasionally, a customer will require a fan to perform a particular function, yet does not know which model to use or even what CFM is necessary. In this case, some fan specification work must be done.

Fan specification is usually not a precise science and can be done confidently when the fan application is understood.

Based on the application, four parameters need to be determined. They are:

1. Fan Model
2. CFM
3. Static Pressure (SP)
4. Loudness Limit (Sones)

The information that follows will help walk you through this type of problem and enable you to select the right fan for the job.

## Fan Model

Fans all perform the basic function of moving air from one space to another. But the great diversity of fan applications creates the need for manufacturers to develop many different models. Each model has benefits for certain applications, providing the most economical means of performing the air movement function. The trick for most users is sorting through all of the models available to find one that is suitable for their needs. Here are some guidelines.

## Direct Drive vs. Belt Drive

Direct drive fans are economical for low volume (2,000 CFM or less) and low static pressure (0.50" or less). They require little maintenance and most direct drive motors can be used with a speed control to adjust the CFM.

Belt drive fans are better suited for air volumes above 2,000 CFM or static pressures above 0.50". Adjustable pulleys allow fan speed and CFM to be adjusted by about 25%. High temperature fans above 50°C (above 122° F) are almost always belt driven.

## Propeller vs. Centrifugal Wheel

Propeller fans provide an economical method to move large air volumes (5,000+ CFM) at low static pressures (0.50" or less). Motors are typically mounted in the airstream which limits applications to relatively clean air at maximum temperatures of 40°C (104° F).

Centrifugal fans are more efficient at higher static pressures and are quieter than propeller fans. Many centrifugal fan models are designed with motors mounted out of the airstream to ventilate contaminated and high temperature air.

## Fan Location

Fan models are designed to be mounted in three common locations: on a roof, in a wall, or in a duct. Whatever the location, the basic fan components do not change. Only the fan housing changes to make installation as easy as possible.

Determining the best location for a fan depends on the airflow pattern desired and the physical characteristics of the building. By surveying the building structure and visualizing how the air should flow, the place to locate the fan usually becomes evident.

Examples of fans installed in common applications are illustrated on the following pages. Even if you come across an application that is not shown in this manual, the concepts remain the same.

## Fan Selection Based On Fan Application

### General Commercial Ventilation



4YU96

**Downblast Exhaust Ventilators  
Centrifugal Direct Drive**  
80-4,300 CFM  
Up to 1.0" SP

**Downblast Exhaust Ventilators  
Centrifugal Belt Drive**  
200-37,000 CFM  
Up to 2.5" SP



4HZ46

**Sidewall Exhaust Ventilators  
Direct Drive**  
100-4,300 CFM  
Up to 1.25" SP

The above stock numbers are designed for exhausting relatively clean air at temperatures up to 130° F. Motors are out of the air-stream. Some of the smaller direct drive ventilators are equipped with 3-speed motors for maximum airflow flexibility. All direct drive units except 1,725 rpm can be used with a speed control.

**Ceiling Ventilators**  
100-1,600 CFM  
Up to 1.0" SP



5AE68



5AE70

**Inline Cabinet Ventilators**  
2,200-3,800 CFM  
Up to 1.0" SP



5AE82

Ceiling ventilators and inline cabinet ventilators are designed for exhausting relatively clean air at temperatures up to 104° F. Motors are in the airstream. All stock numbers are direct drive and can be used with a speed control.



5AV78

**Inline Duct Blowers**  
1,000-23,000 CFM  
Up to 3.0" SP



3F531

**Inline Duct Blowers  
Forward Curve**  
700-10,000 CFM  
Up to 1.0" SP

Inline duct blowers are versatile fans that can be used for exhaust or supply and can be mounted in any position. Two removable side panels provide access for service.



# Fan Selection Based On Fan Application

## Typical Commercial Ventilation Installations

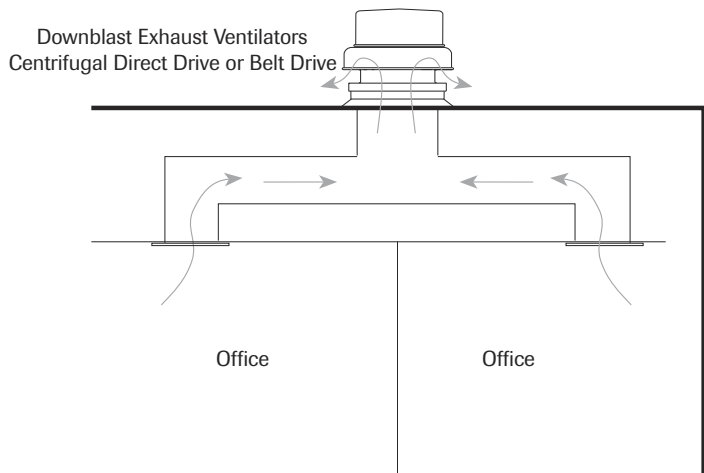

This drawing demonstrates how to ventilate more than one area with a single fan.

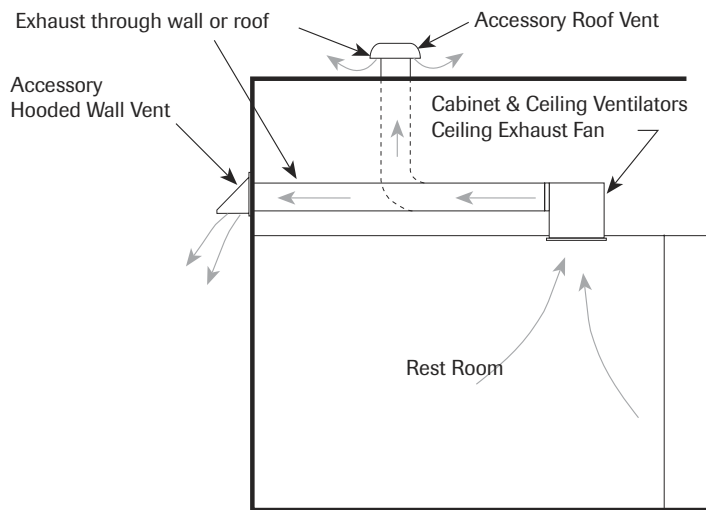

Typical restroom exhaust system

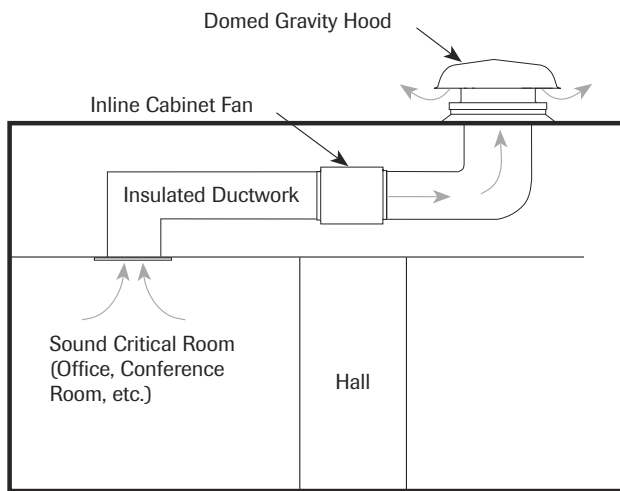

For ultra-quiet applications, insulate ductwork and mount fan over a less sound critical area.

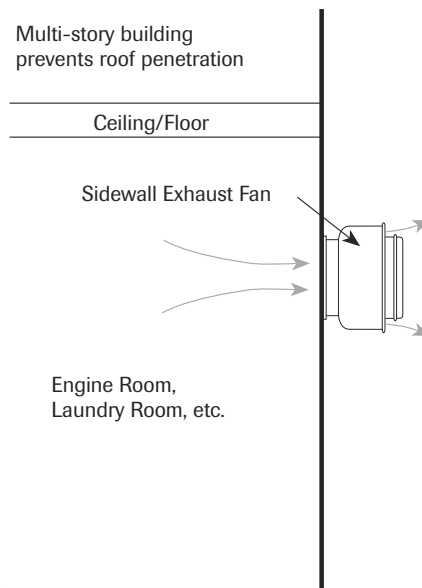

Exhausting through an outside wall is often the best solution when penetrating the roof is not practical.

\* Illustrations show fan types typically used in these applications. The specific fan stock number required depends on the conditions of each individual application.

## Fan Selection Based On Fan Application

### Commercial Kitchen Ventilation

#### Recommended Exhaust Fans



4YY14

**Upblast Exhaust Ventilators**  
**Centrifugal Belt Drive**  
 100-19,000 CFM  
 Up to 2.0" SP



4HZ46

**Sidewall Exhaust Ventilators**  
**Centrifugal Direct Drive**  
 100-4,300 CFM  
 Up to 1.25" SP



3C494

**Backward Incline**  
**Belt Drive Blowers**  
 1,000-30,000 CFM  
 Up to 4.0" SP

The above stock numbers are designed for exhausting dirty or grease-laden air up and away from the roof line or away from the wall in commercial restaurant applications. All three models are UL 762 listed for restaurant applications and for operation with air temperatures up to 300° F.

#### Recommended Supply Fans



5AU56

**Filtered Supply Ventilators**  
**Centrifugal Belt Drive**  
 900-14,300 CFM  
 Up to 2.0" SP



5AV78

**Inline Duct Blowers**  
 1,000-23,000 CFM  
 Up to 3.0" SP

The above stock numbers are designed to provide efficient economical make-up air to replenish the air exhausted through the kitchen hood. Provisions for make-up air must be considered for proper kitchen ventilation.

# Fan Selection Based On Fan Application

## Commercial Kitchen Ventilation

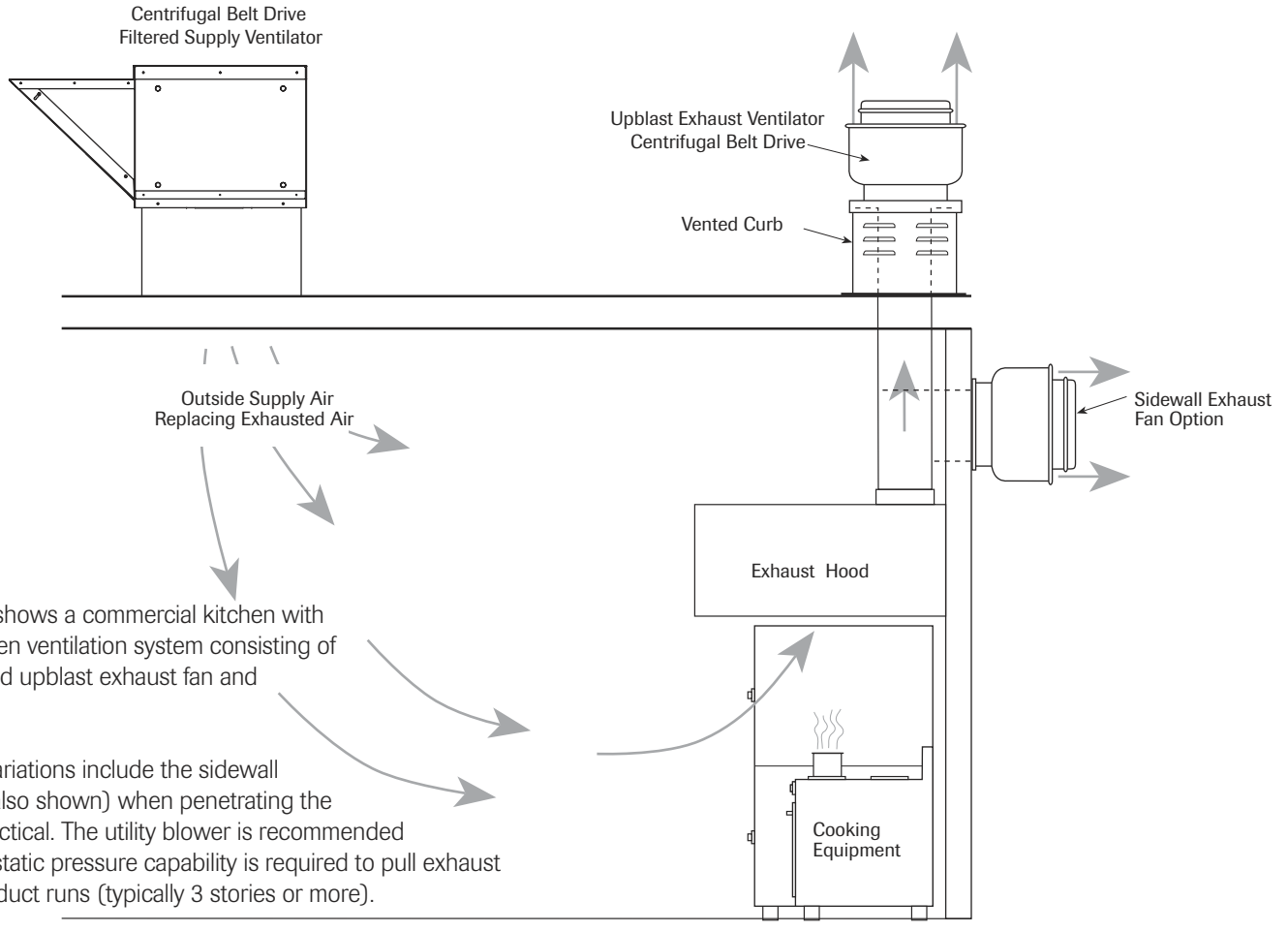

This drawing shows a commercial kitchen with a typical kitchen ventilation system consisting of a roof mounted upblast exhaust fan and a supply fan.

Exhaust fan variations include the sidewall exhaust fan (also shown) when penetrating the roof is not practical. The utility blower is recommended when higher static pressure capability is required to pull exhaust through long duct runs (typically 3 stories or more).

## Fan Sizing

### Exhaust

When not specified by local codes, the following guidelines may be used to determine the minimum kitchen hood exhaust CFM. Some local codes require 100 CFM/Ft.<sup>2</sup> of hood area for wall style hoods.

### Supply

Recommended supply airflow is 90% of exhaust CFM. The remaining 10% of supply air will be drawn from areas adjacent to the kitchen, which helps prevent undesirable kitchen odors from drifting into areas such as the dining room.

|                    | Type of Cooking Equipment     | CFM/Ft. <sup>2</sup> of Hood |
|--------------------|-------------------------------|------------------------------|
| <b>Light Duty</b>  | Oven, Range, Kettle           | 50                           |
| <b>Medium Duty</b> | Fryer, Griddle                | 75                           |
| <b>Heavy Duty</b>  | Charbroiler, Electric Broiler | 100                          |

Static pressure typically ranges from .625" to 1.0" for 1 story buildings.

## NFPA Considerations

The National Fire Protection Association specifies minimum distance criteria for restaurant exhaust and supply:

1. Roof deck to top of exhaust fan windband - 40" min.
2. Roof deck to top of curb - 18" min.
3. Supply fan intake - 10' min. from all exhaust fans.

For applications where the 10' horizontal distance cannot be met, vertical separation between exhaust and supply must be at least 3 feet.

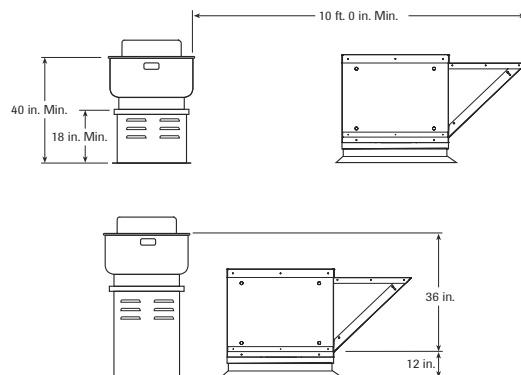

# Fan Selection Based On Fan Application

## General Industrial Ventilation



5AV95

### Sidewall Propeller Fans

2,000-68,500 CFM  
Up to 1.0" SP

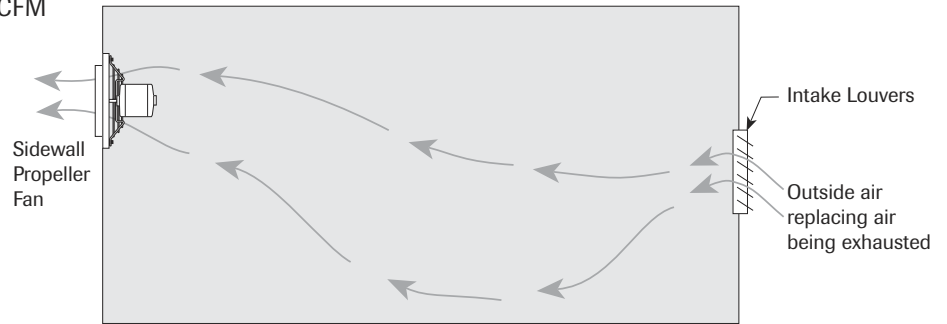

4YY23

### Upblast Exhaust Ventilators

Axial Belt Drive  
5,400-64,000 CFM  
Up to 0.5" SP

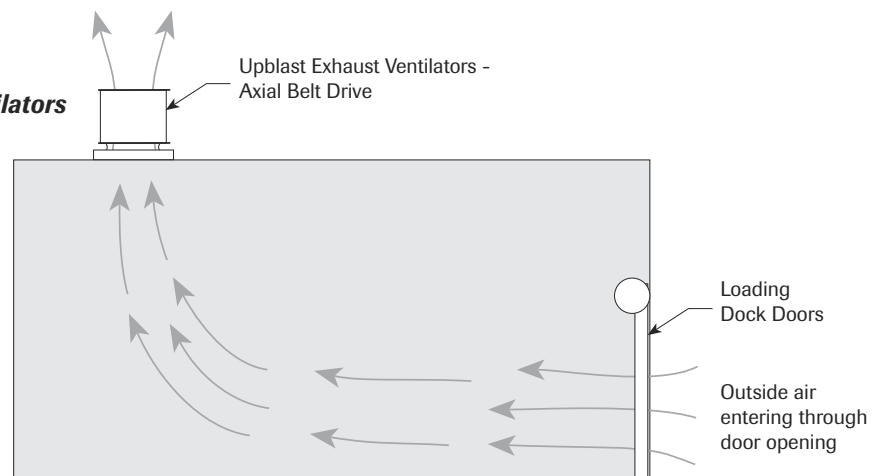

7CF46

### Hooded Roof Fans

4,500-23,000 CFM  
Up to 0.375" SP

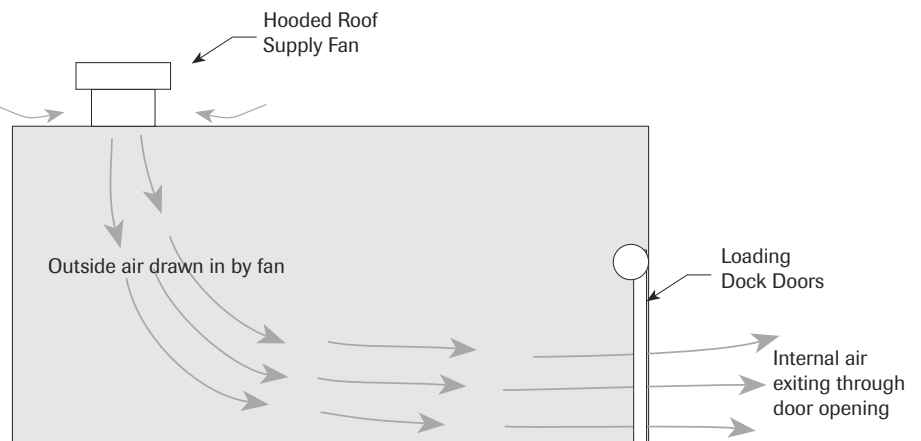

## Typical Applications

Propeller fans are ideal for ventilating high air volumes at low static pressures (0.50" or less). Industrial applications often include factories and warehouses. A variety of fan models offer flexibility for roof or wall mount as well as exhaust or supply. However, because the motors are mounted in the airstream, these models are not recommended for temperatures above 104° F.

# Fan Selection Based On Fan Application

## General Industrial Ventilation



3C494

**Backward Incline Belt Drive Blowers**  
1,000-30,000 CFM  
Up to 4.0" SP

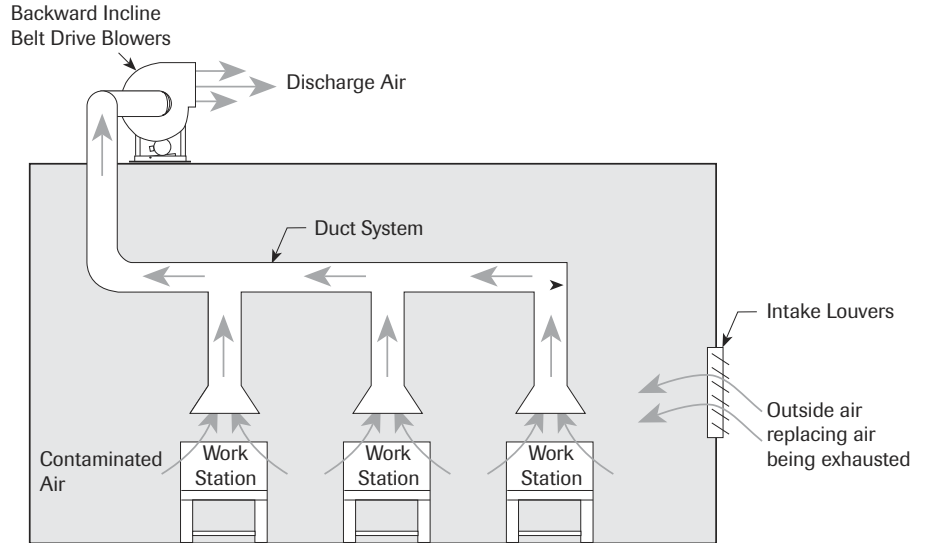

5AV78

**Inline Duct Blowers**  
1,000-23,000 CFM  
Up to 3.0" SP

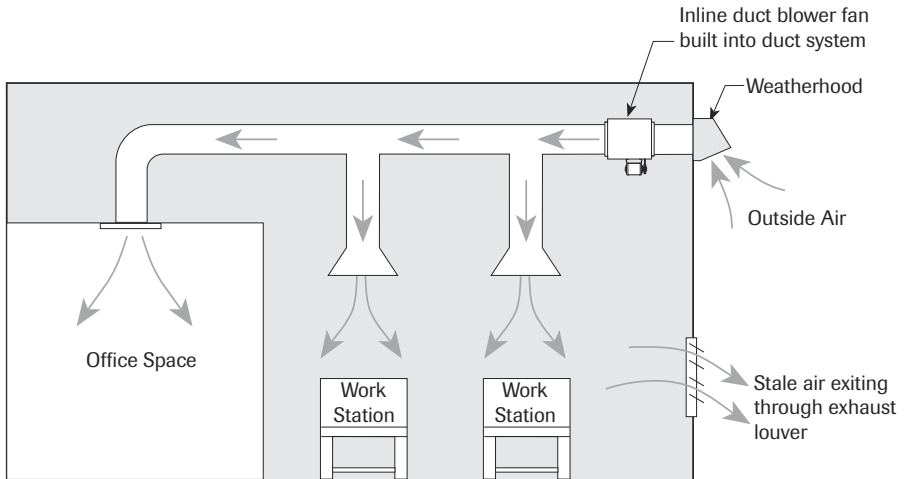

## Typical Applications

Blowers are general, all-purpose fans that are capable of moving high air volumes against high static pressures (up to 4.0" WG). High static pressures are generated by long or complex duct systems, especially when capture hoods are present. Both models can be used for either exhaust or supply. Belt drive blowers are designed to be mounted indoors or outdoors, while inline duct blowers can be used indoors only.

# Fan Selection Based On Fan Application

## Determining CFM

Once the fan type is known, the amount of air exchanged must be determined (CFM). Your local building codes should contain information pertaining to the suggested air changes for proper ventilation.

The ranges specified will adequately ventilate the corresponding areas in most cases. However, extreme conditions may require “Minutes per Change” outside of the specified range. To determine the actual number needed within a range, consider the geographic location and average duty level of the area. For hot climates and heavier than normal area usage, select a lower number in the range to change the air more quickly. For moderate climates with lighter usage, select a higher number in the range.

To calculate the CFM required to adequately ventilate an area, divide the room volume by the appropriate “Minutes per Change” value.

### Suggested Air Changes for Proper Ventilation

$$CFM = \frac{\text{Room Volume}}{\text{Min./Chg.}}$$

$$\text{Room Volume} = L \times W \times H$$

| Area            | Min./Chg. | Area           | Min./Chg. | Area            | Min./Chg. |
|-----------------|-----------|----------------|-----------|-----------------|-----------|
| Assembly Hall   | 3-10      | Dance Hall     | 3-7       | Mill            | 3-8       |
| Attic           | 2-4       | Dining Room    | 4-8       | Office          | 2-8       |
| Auditorium      | 3-10      | Dormitories    | 5-8       | Packing House   | 2-5       |
| Bakery          | 2-3       | Dry Cleaner    | 2-5       | Plating Room    | 1-5       |
| Bar             | 2-4       | Engine Room    | 1-3       | Printing Plant  | 3-8       |
| Barn            | 12-18     | Factory        | 2-7       | Projection Room | 1-2       |
| Beauty Parlor   | 2-5       | Foundry        | 1-5       | Recreation Room | 2-8       |
| Boiler Room     | 1-3       | Garage         | 2-10      | Residence       | 2-6       |
| Bowling Alley   | 3-7       | Generator Room | 2-5       | Restaurant      | 5-10      |
| Cafeteria       | 3-5       | Gymnasium      | 3-8       | Restroom        | 5-7       |
| Church          | 4-10      | Kitchen        | 1-5       | Store           | 3-7       |
| Classroom       | 4-6       | Laboratory     | 2-5       | Transfer Room   | 1-5       |
| Club Room       | 3-7       | Laundry        | 2-4       | Warehouse       | 3-10      |
| Corridors/Halls | 6-20      | Machine Shop   | 3-6       |                 |           |
| Dairies         | 2-5       | Meeting Room   | 3-10      |                 |           |

## Sample Scenario

A building requires an exhaust fan to ventilate a general office. The office measures 25' x 40' x 8'. The office is generally crowded.

Solution:

The total room volume is 25' x 40' x 8' = 8000 ft<sup>3</sup>. From the chart, the range for “Minutes per Change” for a general office is 2-8. Since the office usage is heavier than normal, 4 minutes per change is recommended.

$$\frac{8000 \text{ ft}^3}{4 \text{ min}} = 2000 \text{ CFM}$$

Since the air to be exhausted is relatively clean, this is an ideal application for a Dayton Belt-Drive Downblast Centrifugal Roof Ventilator.

NOTE: For simplicity in this example, it can be assumed that make-up air was provided through a set of louvers at the wall furthest from the exhaust fan. If there were no provisions for make-up air in this room, a supply fan would also have to be sized.

The supply CFM should generally equal the exhaust CFM. Supply fan location should be as far as possible from the exhaust fan.

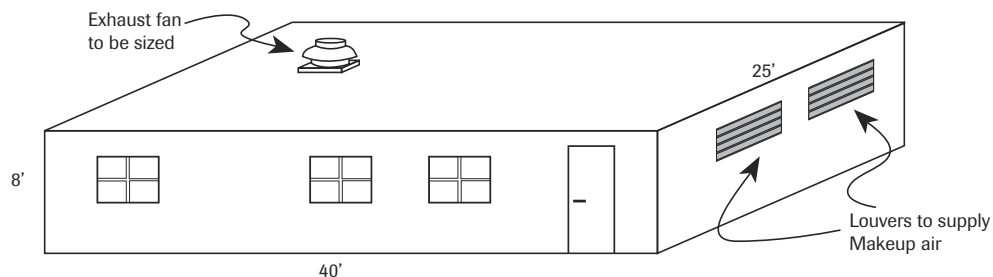



# Fan Selection Based On Fan Application

## Determining Static Pressure

The pressure generated by fans in ductwork is typically very small. An accurate measurement of static pressure is critical to proper fan selection however. Fan static pressure is measured in inches of water gauge. One pound per square inch is equivalent to 2.77" SP. Static pressure in fan systems is typically less than 2" SP, or 0.072 Psi.

The Exhaust Fan drawing below to the left illustrates how static pressures are measured in ductwork with a manometer.

A pressure differential between the duct and the atmosphere will cause the water level in the manometer legs to rest at different levels. This difference is the static pressure measured in inches of water gauge.

In the case of the exhaust fan in the drawing, the air is being drawn upward through the ductwork because the fan is producing a low pressure region at the top of the duct. This is the same principle that enables beverages to be sipped through a straw.

The amount of static pressure that the fan must overcome depends on the air velocity in the ductwork, the number of duct turns (and other resistive elements), and the duct length. For properly designed systems with sufficient make-up air, the guidelines in the table below to the right can be used for estimating static pressure.

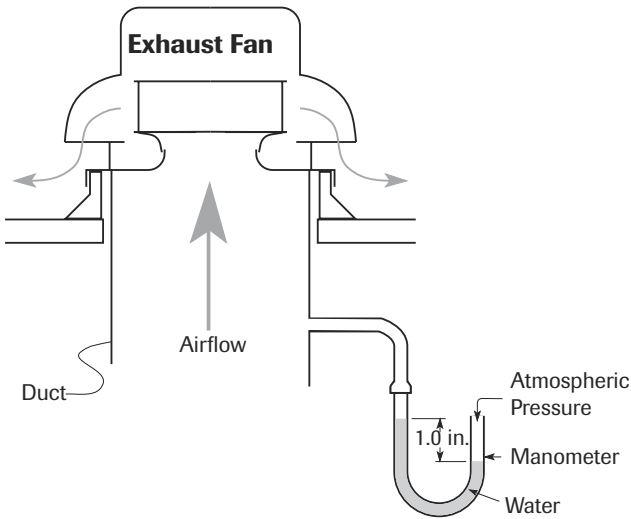

| STATIC PRESSURE GUIDELINES   |  |
|--|--|
| Non-Ducted:  | 0.05" to 0.20"   |
| Ducted:  | 0.2" to 0.40" per 100 feet of duct (assuming duct air velocity falls within 1,000-1,800 feet per minute) |
| Fittings:  | 0.08" per fitting (elbow, register, grill, damper, etc.)   |
| Kitchen Hood Exhaust:  | 0.625" to 1.50"  |
| Important: Static pressure requirements are significantly affected by the amount of make-up air supplied to an area. Insufficient make-up air will increase static pressure and reduce the amount of air that will be exhausted. Remember, for each cubic foot of air exhausted, one cubic foot of air must be supplied. |  |

To calculate the system losses, one must know the ductwork system configuration (see the Ductwork drawing below to the right).

This duct is sized for air velocities of 1,400 feet per minute. Referring to the static pressure chart, that will result in about 0.3" per 100 feet. Since we have 10 feet of total ductwork, our pressure drop due to the duct is:

$$\frac{0.3''}{100\text{ft.}} \times 10 \text{ ft.} = .03''$$

There is also a 0.08" pressure drop for each resistive element or fitting. For this example, there are 5 fittings: one grill, two duct turns, one damper and louvers in the wall of the office. The total pressure drop for fittings is:

$$5 \times 0.08'' = 0.4''$$

Therefore, the total pressure drop is:

$$0.03'' + 0.40'' = 0.43''$$

For convenience in using selection charts, round this value up to the nearest 1/8", which would be 0.50" SP.

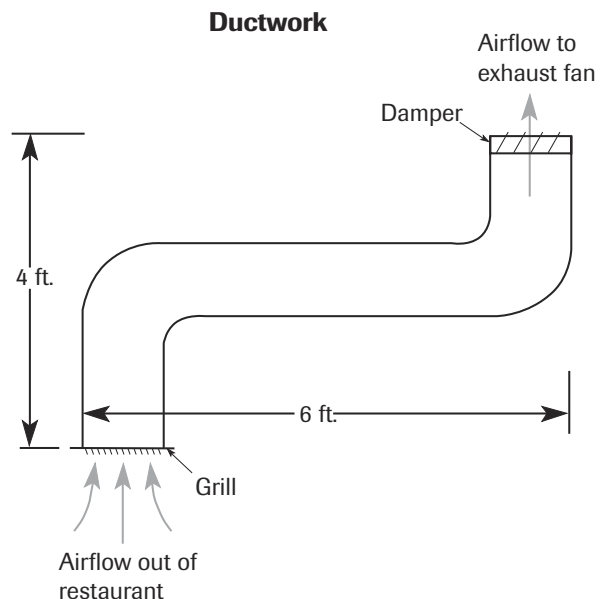

## Fan Selection Based On Fan Application

### Preliminary Selection

At this point in the selection process, we know the fan, CFM, and SP. With this information we can refer to the performance charts for the selected stock number to determine the available sizes to move 2000 CFM against 0.50" SP.

In our case, all of the criteria can be met by more than one particular stock number. When this occurs, choose one that provides the greatest airflow range about the desired CFM. For example, many direct drive fans have three speeds. If possible, choose a size that uses the middle rpm. This will allow some final system adjustment if the actual CFM the job requires is somewhat higher or lower once the fan is installed. Belt driven fans have adjustable motor pulleys which allow for the fan speed to be varied approximately 10%. With belt drive units, avoid selecting a fan near the maximum rpm of a size to allow for final adjustments as necessary.

For this example, there are three stock numbers to choose from. These sizes, along with their performance data are listed in the table below.

| Combo Stock Number | Performance Data |               |         | RPM  |
|--------------------|------------------|---------------|---------|------|
|                    | CFM              | Sones @ 0.250 | Max Bhp |      |
| 7A556              | 2166             | 13.9          | .53     | 1360 |
| 7A559              | 2010             | 11.5          | .34     | 945  |
| 7A568              | 2087             | 8.5           | .25     | 665  |

### Stability Considerations

Whenever there is more than one size to choose from, it is not recommended to select from the performance box in the far right column for any given rpm unless the SP is known to be accurate. For example, the stock number 7A559 selection of 2010 CFM at 0.50" SP is the far right selection at 945 rpm. The next box to the right (0.750" SP) is empty because the performance at that point is unstable. This means that 2010 CFM at 0.50" SP is marginally stable.

| Stock Number | Wheel Dia. | HP    | Combo Stock # | Fan RPM | Max BHP | Sones @ 0.250" | CFM Air Delivery @ Static Pressure Shown |        |        |        |        |        |        |
|--------------|------------|-------|---------------|---------|---------|----------------|--|--------|--------|--------|--------|--------|--------|
|              |            |       |               |         |         |                | 0.000"                                   | 0.125" | 0.250" | 0.375" | 0.500" | 0.750" | 1.000" |
| 4YU94 *      | 13-1/4     | 1/4   | 7A551         | 1395    | 0.26    | 12.3           | 1692                                     | 1625   | 1557   | 1484   | 1404   | 1214   | 907    |
|              |            | 1/3   | 7A552         | 1550    | 0.36    | 14.3           | 1880                                     | 1820   | 1759   | 1696   | 1629   | 1475   | 1289   |
|              |            | 1/2   | 7A553         | 1725    | 0.50    | 17.0           | 2093                                     | 2038   | 1984   | 1928   | 1871   | 1743   | 1600   |
| 4YU95 *      | 14-3/4     | 1/4   | 7A554         | 1075    | .26     | 9.4            | 1994                                     | 1882   | 1771   | 1647   | 1490   | -      | -      |
|              |            | 1/3   | 7A555         | 1170    | 0.34    | 10.8           | 2170                                     | 2067   | 1966   | 1859   | 1734   | 1356   | -      |
|              |            | 1/2   | 7A556         | 1360    | 0.53    | 13.9           | 2523                                     | 2433   | 2347   | 2259   | 2166   | 1943   | 1602   |
|              |            | 3/4   | 7A557         | 1545    | 0.78    | 17.4           | 2866                                     | 2787   | 2710   | 2634   | 2556   | 2384   | 2177   |
|              |            | 1     | 7A558         | 1705    | 1.05    | 20             | 3163                                     | 3091   | 3020   | 2952   | 2883   | 2739   | 2574   |
| 4YU96 *      | 16-3/4     | 1/3   | 7A559         | 945     | 0.34    | 11.5           | 2791                                     | 2612   | 2434   | 2236   | 2010   | -      | -      |
|              |            | 1/2   | 7A560         | 1100    | 0.53    | 14.1           | 3249                                     | 3095   | 2943   | 2787   | 2615   | 2198   | -      |
|              |            | 3/4   | 7A561         | 1250    | 0.79    | 17.0           | 3692                                     | 3557   | 3422   | 3289   | 3149   | 2838   | 2444   |
|              |            | 1     | 7A562         | 1375    | 1.05    | 19.6           | 4062                                     | 3938   | 3815   | 3694   | 3571   | 3304   | 3007   |
| 4YU97 *      | 18-1/2     | 1/3   | 7A563         | 810     | 0.35    | 8.7            | 3150                                     | 2997   | 2832   | 2624   | 2375   | -      | -      |
|              |            | 1/2   | 7A564         | 940     | 0.54    | 12.0           | 3655                                     | 3527   | 3388   | 3234   | 3052   | 2601   | -      |
|              |            | 3/4   | 7A565         | 1055    | 0.77    | 14.9           | 4102                                     | 3990   | 3867   | 3742   | 3596   | 3252   | 2811   |
|              |            | 1     | 7A566         | 1185    | 1.1     | 17.8           | 4608                                     | 4508   | 4401   | 4290   | 4179   | 3900   | 3575   |
|              |            | 1-1/2 | 7A567         | 1335    | 1.57    | 21             | 5191                                     | 5102   | 5010   | 4913   | 4814   | 4599   | 4344   |
|              |            | 2     | 7A660         | 1460    | 2.05    | 24             | 5677                                     | 5596   | 5514   | 5425   | 5336   | 5155   | 4938   |
| 4YU98 *      | 21-1/2     | 1/3   | 7A568         | 665     | 0.35    | 8.5            | 3680                                     | 3378   | 3085   | 2706   | 2087   | -      | -      |
|              |            | 1/2   | 7A569         | 770     | 0.55    | 10.7           | 4261                                     | 4013   | 3744   | 3477   | 3141   | -      | -      |
|              |            | 3/4   | 7A570         | 860     | 0.77    | 12.9           | 4759                                     | 4548   | 4289   | 4068   | 3811   | 3085   | -      |
|              |            | 1     | 7A571         | 965     | 1.09    | 15.4           | 5340                                     | 5158   | 4927   | 4720   | 4520   | 4015   | 3240   |
|              |            | 1-1/2 | 7A572         | 1090    | 1.56    | 18.9           | 6032                                     | 5870   | 5682   | 5473   | 5301   | 4925   | 4450   |
|              |            | 2     | 7A665         | 1200    | 2.09    | 23             | 6640                                     | 6494   | 6336   | 6145   | 5969   | 5651   | 5274   |

\* Drive package not included in unit

## Fan Selection Based On Fan Application

### Sound Levels

In many cases, the sound generated by a fan must be considered. For the fan industry, a common unit for expressing sound pressure level is the sone. In practical terms, the loudness of one sone is equivalent to the sound of a quiet refrigerator heard from five feet away in an acoustically average room.

Sones are a linear measurement of sound pressure levels. For example, a sound level of 10 sones is twice as loud as 5 sones.

Refer to the Suggested Limits for Room Loudness chart to determine the acceptable sone range for the application. As a general guideline, choose a fan that has a sone value within the range specified.

NOTE: Rooms with hard construction (concrete block, tile floors, etc.) reflect sound. For these rooms, select fans on the lower end of the range. Rooms with soft construction of those with carpeting and drapes, etc., absorb sound. For these rooms, fans near the higher end of the range may be selected.

Our example describes an exhaust fan for an office. Referring to the Suggested Limits for Room Loudness chart, offices should have a loudness range from 4 to 12 sones. Of our remaining three selections, only the 4YU97 has a sone value of less than 12. Therefore, the 4YU97 is the best selection for this application.

| <b>Suggested Limits for Room Loudness</b> |            |  |
|---|------------|--|
| <b>Sones</b>                              | <b>DBA</b> |  |
| 1.3-4.0                                   | 32-48      | Private homes (rural and suburban)                           |
| 1.7-5.0                                   | 36-51      | Conference rooms   |
| 2.0-6.0                                   | 38-54      | Hotel rooms, libraries, movie theatres, executive offices    |
| 2.5-8.0                                   | 41-58      | Schools and classrooms, hospital wards, and operating rooms  |
| 3.0-9.0                                   | 44-60      | Court rooms, museums, apartments, private homes              |
| 4.0-12.0                                  | 48-64      | Restaurants, lobbies, general open offices, banks            |
| 5.0-15.0                                  | 51-67      | Corridors and halls, cocktail lounges, washrooms and toilets |
| 7.0-21.0                                  | 56-72      | Hotel kitchens and laundries, supermarkets                   |
| 12.0-36                                   | 64-80      | Light machinery, assembly lines                              |
| 15.0-50                                   | 67-84      | Machine shops  |
| 25-60                                     | 74-87      | Heavy machinery  |

From AMCA Publication 302 (Application of Sone Ratings for Non-Ducted Air Moving Devices with Room-Sone-dBA correlations).

### Motor Horsepower

The motor horsepower for direct drive fans is always sized by Dayton and does not require further consideration. For belt drive models, the catalog identifies which horsepower is recommended. However, there are times when it is wise to bump the horsepower one size. For example, the hp recommended for the 4YU97 at 810 rpm is 1/3 hp.

Although a 1/3 hp motor is recommended, it is not necessarily a good motor selection for this application. Our static pressure of 0.5" was only an estimate. It may actually turn out to be .625".

If this is the case, we will need a 1/2 hp motor because our fan will have to run at almost 900 rpm (refer to performance box - 2844 CFM at 0.625" SP). Therefore choosing a 1/2 hp motor in this case is exercising good judgement.

The complete model designation for this application is 7A564.

NOTE: the 7A564 has an rpm range of 700-940 (refer to stock number column in catalog). This means that if the static pressure is less than estimated, say 0.25" SP, the fan can be slowed down to accommodate this condition.

## Fan Selection Based On Fan Application

### Roof Fan Installation

To ensure proper fan performance as cataloged, caution must be exercised in fan placement and connection to the ventilation system. Obstructions, transitions, poorly designed elbows, improperly selected dampers, etc., can cause reduced performance, excessive noise, and increased mechanical stressing. For the fan to perform as published, the system must provide uniform and stable airflow into the fan.

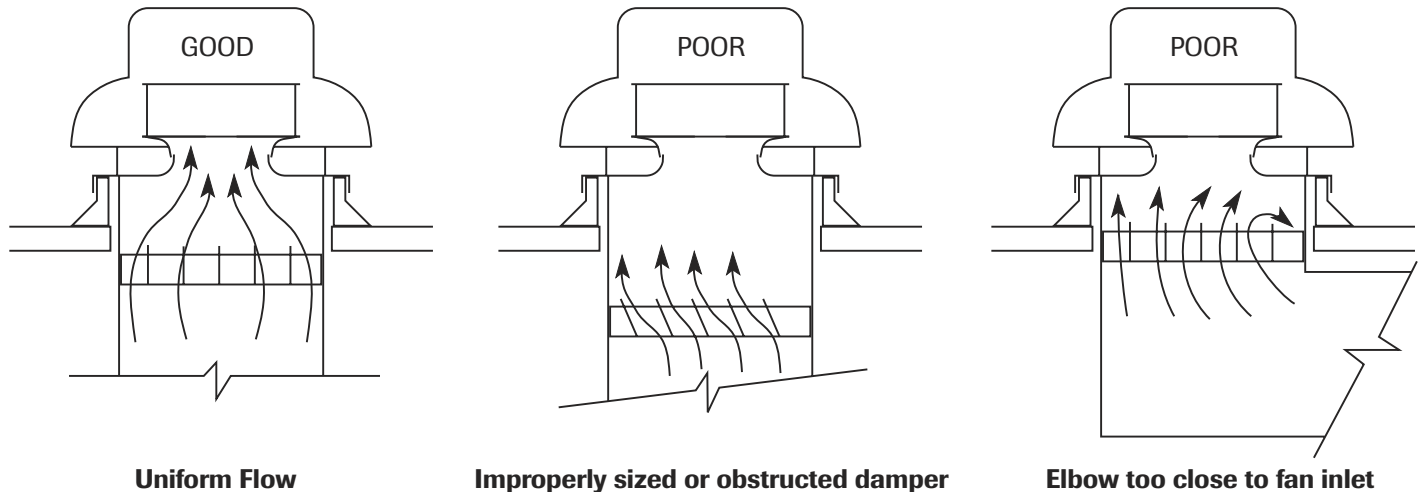

Uniform Flow

Improperly sized or obstructed damper

Elbow too close to fan inlet

### Wall Fan Installation

#### Good Installation

1. Exhaust fans are placed on the opposite end of a structure from the intake or supply area. Fresh air is drawn through the entire structure.
2. Do not locate exhaust and supply fans on the same wall. This short circuits the airflow pattern, and does not allow for complete ventilation of the structure.
3. Intake shutters and supply fans should be located on the windward side of a building to capture the prevailing wind. Exhaust fans should blow with prevailing winds.

#### Bad Installation

1. Do not locate exhaust fans where they could push against each other. When unavoidable, separate the fan discharge by at least 6 wheel or propeller diameters.
2. Install exhaust fans in a location to eliminate recirculation into other parts of the building such as through open windows or into supply fans.

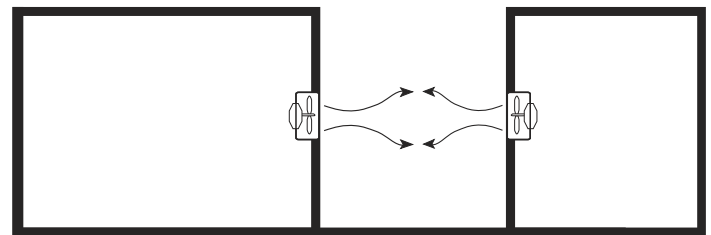
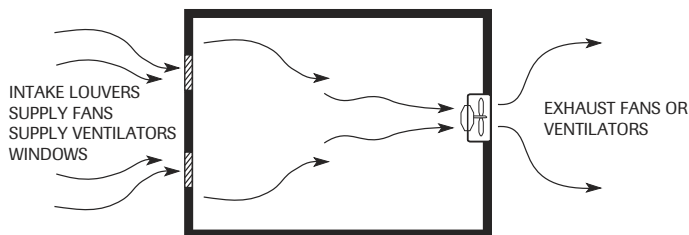

## Fan Performance

The first two sections of this guide contain information needed to select the right fan for the particular application. The information in this section is useful once the fan has been selected and installed on the job.

The fan curves and system resistance curves below will help to solve fan performance problems that may be encountered in a variety of applications.

### Fan Dynamics

A fan is simply an air pump. The rate at which a fan can “pump” air depends on the pressure the fan must overcome. This principle also relates to water pumps. A water pump is able to deliver more water through a 2” diameter hose than 1” diameter hose because the 1” hose creates more resistance to flow.

For a fan, every flow rate (CFM - Cubic Feet per Minutes) corresponds to a specific resistance to flow (SP = static pressure). The series of CFM, SP points for a fan at a constant rpm is called a fan curve. A fan curve at 700 rpm is shown below on the left.

At 0.25” SP, this fan will deliver 1000 CFM. If the pressure increases, CFM decreases. If the pressure decreases, CFM will increase.

At 700 rpm, the operating point will slide along the fan curve as static pressure changes, but it will never lie off the curve. In order for a fan to perform at a point off the curve, the rpm must be changed.

The figure below on the right illustrates how rpm affects the fan curve. Notice that the general shape of the curves are the same. Changing rpm simply moves the curve outward or inward.

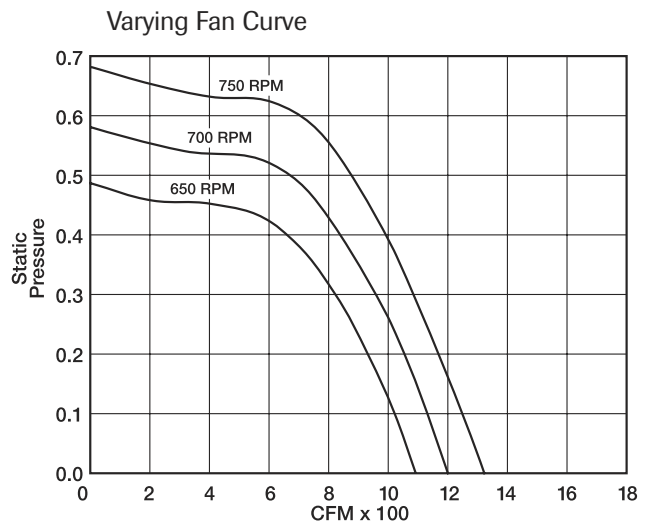
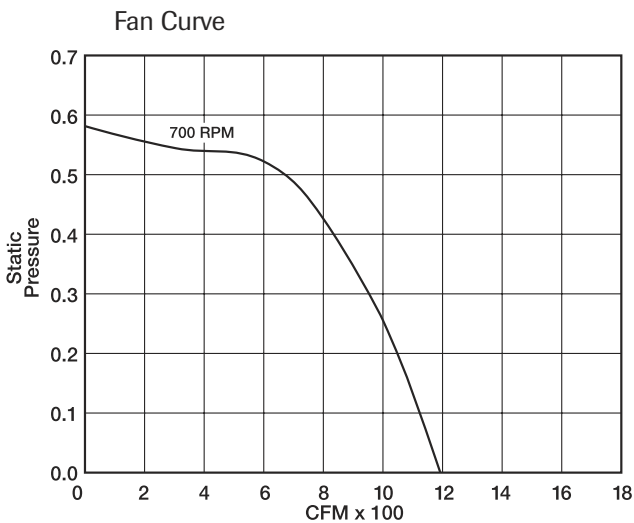

### System Dynamics

For a given flow rate (CFM), an air distribution system produces a resistance to airflow (SP). This resistance is the sum of all static pressure losses as the air flows through the system. Resistance producing elements include ductwork, dampers, grills, coils, etc.

A fan is simply the device that creates the pressure differential to move air through the system.

The greater the pressure differential created by the fan, the greater the volume of air moved through the system. Again, this is the same principle that relates to water pumps. The main difference in our case is that the fan is pumping air.

Tests have established a relationship between CFM and SP. This relationship is parabolic and takes the form of the following equation:

$$SP = K \times (CFM)^2$$

Where K is the constant that reflects the “steepness” of the parabola. This equation literally states that SP varies as the square of the CFM.

For example, whenever the CFM doubles, the SP will increase 4 times. The figures on the next page graphically illustrate this concept.

# Fan Performance

## System Dynamics (Cont.)

System Resistance Curve

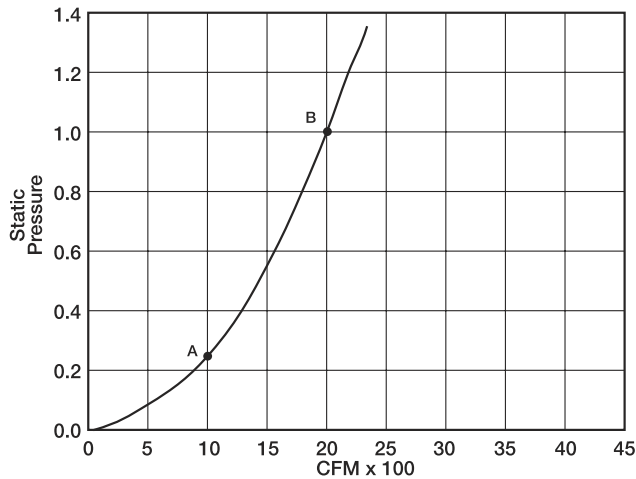

Varying System Resistance Curve

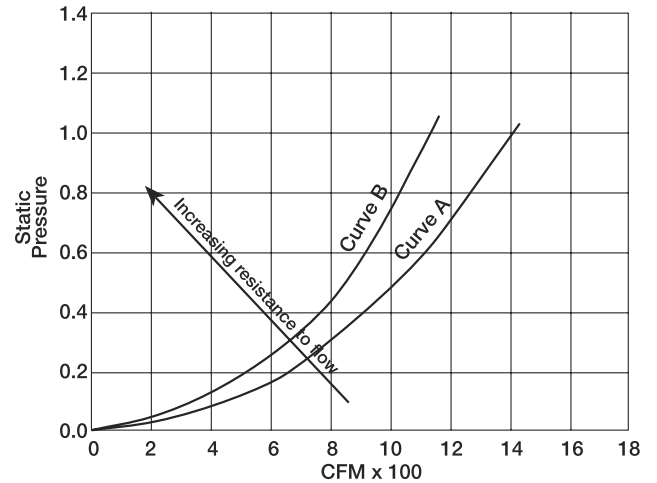

### Sample problem

If a system is designed to move 1,000 CFM at a resistance of 0.25" SP, what static pressure would the fan have to overcome to produce 2,000 CFM of airflow?

#### Solution:

Since static pressure varies as the square of CFM, we can solve for the new SP ( $SP_2$ ) with the following equation:

$$SP_2 = SP_1 \times \left( \frac{CFM_2}{CFM_1} \right)^2 = 0.25" \times \left( \frac{2000 \text{ CFM}}{1000 \text{ CFM}} \right)^2 = 1.0"$$

Referring to the figure above on the left, this results in sliding up the system resistance curve from Point A to Point B.

For this system, it is impossible to move 2,000 CFM at only 0.25" SP. For any given system, every CFM requires a unique SP. This series of CFM/SP points forms a system resistance curve such as the one above on the left. Once the system resistance curve is defined, changing the fan rpm will change the CFM and SP simultaneously, which results in sliding along the system resistance curve.

Note: Physically changing the system will alter the system resistance. For example, closing a damper from 100% open to only 50% open will add resistance and increase the "steepness" of the system resistance curve. The same effect occurs as filters become dirty. The figure above on the left illustrates this point.

Curve A defines a system that requires 0.5" SP to move 1,000 CFM. Curve B requires 0.75" SP to move the same amount of air. This is typical of how a system reacts to increased resistance.

In this section, there are three key points to emphasize:

1. As airflow through a system changes, so does the static pressure.
2. For a steady-state system, operating points must lie on the curve defining that system's CFM/SP characteristics.
3. As the system's resistive elements change, the steepness of the system resistance curve changes.

### Combining Fan and System Dynamics

The previous two sections introduced fan curves and system resistance curves. This section will show how these relate to each other to provide an understanding of the way the fan-system operates as a complete entity.

Remember that a fan curve is the series of points at which the fan can operate at a constant rpm. Likewise, a system resistance curve is the series of points at which the system can operate. The operating point (CFM, SP) for the fan-system combination is where these two curves intersect.



## Combining Fan and System Dynamics (Cont.)

The operating point of the fan and the system is the point where these two curves intersect. This intersection will determine the CFM and SP delivered.

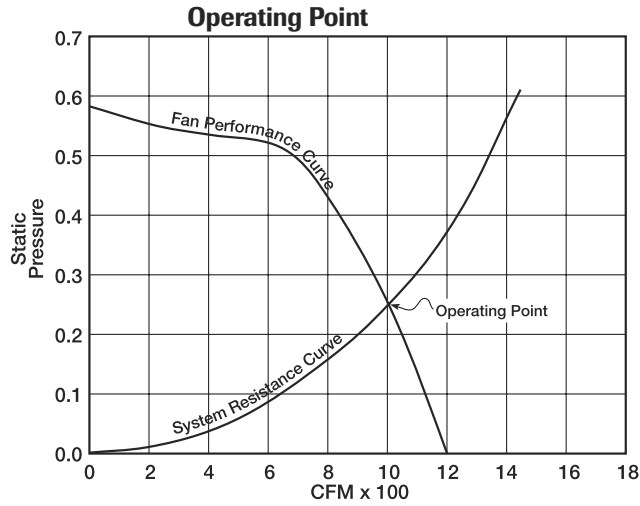

## Adjusting Fan Performance

There is a direct relationship between CFM and rpm within a system. Doubling the fan rpm will double the CFM delivered.

### Sample problem:

The figure on page 19 showed a fan curve at 700 rpm which had an operating point of 1,000 CFM and 0.25" SP. What rpm is required to move 2,000 CFM through the same system?

### Solution:

Within a system, CFM is directly related to rpm. Therefore, the new rpm ( $rpm_2$ ) can be determined from the following equation:

$$rpm_2 = rpm_1 \times \left( \frac{CFM_2}{CFM_1} \right) = 700 \text{ rpm} \times \left( \frac{2,000 \text{ CFM}}{1,000 \text{ CFM}} \right) = 1,400 \text{ rpm}$$

Referring to figure at right, this results in sliding up the system resistance curve from 700 rpm to 1,400 rpm.

Notice that as we doubled our airflow from 1,000 CFM to 2,000 CFM, the SP went up from 0.25" to 1.0". It must be kept in mind that we are not changing the system, only increasing fan speed. Therefore, we must remain on the system resistance curve. Within a system, SP varies as the square of CFM. Since CFM and rpm are directly proportional, an equation relating SP and rpm can be derived as follows:

$$SP_2 = SP_1 \times \left( \frac{rpm_2}{rpm_1} \right)^2$$

For our example,

$$SP_2 = 0.25" \times \left( \frac{1,400 \text{ rpm}}{700 \text{ rpm}} \right)^2 = 1.0"$$

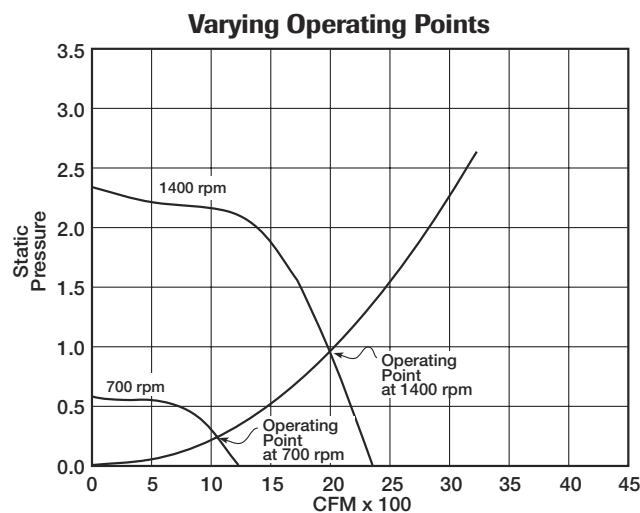

This verifies the operating point on the 1,400 rpm curve (2,000 CFM at 1.0" SP). With this example, it should be clear how CFM, rpm and SP tie together in steady-state system.

## Safety Practices

The safe operation of any air-moving device is an essential part of fan selection and installation. Always contact your local authority having jurisdiction for specific safety requirements. Always follow national codes such as the National Electrical Code (also called NFPA 70), Occupational Safety and Health Act (OSHA), and the recommendations of the National Fire Protection Association (NFPA).

### Safety Guard

1. A protective device must always be installed to prevent contact with the rotating blades or wheel of any air-moving device regardless of its location. Guarding in accordance with OSHA regulations is required on installations located less than 7 ft above the floor level where untrained personnel or the general public have access to the equipment.
2. Properly secure the duct connections to centrifugal or tubeaxial fans to prevent the exposure of rotating parts.
3. A guard should be installed to prevent contact with the fan shaft, pulleys, belts, drive couplings and heat slinger.
4. Never remove fan guards, safety guards, inlet or outlet ducts while the fan is in operation.

### Duct Systems and Access Doors

1. Intakes to ducts would be screened to prevent foreign objects from reaching the fan discharge as a projectile, thereby damaging the wheel or passing through the fan.
2. A cleanout or access door built into centrifugal fans should never be removed while the fan is in operation. An explosive opening of the door or flying debris may result.
3. Inspection doors in ductwork should never be opened while the fan is in operation.

### Electrical Hazards

1. Follow all local electrical codes as well as the National Electrical Code when wiring a fan installation.
2. The fan and motor must be securely and adequately grounded. A grounded metal-clad raceway system or separate ground wire connected to the bare metal of the fan and motor frame should be utilized.
3. Always disconnect the power source before working on or near a fan or motor. If the power disconnect switch is out-of-sight, lock it in the open position and tag it to prevent someone from inadvertently closing the switch.
4. Repair work on a fan, motor, or system should never be attempted by untrained or unauthorized personnel.

### Critical Applications

1. When fans are installed in a life support ventilation system or critical application where fan failure could result in loss of life or injury, the installer or user should provide adequate back up ventilation, supplementary natural ventilation, or a failure alarm system.
2. Always have a spare motor, belt, or duplicate fan available as a replacement in the event of fan failure.

### Hazardous Environment

1. Don't use a fan, motor, or other electrical device in a hazardous environment unless the components are specifically built and approved for such use.  
NOTE: Certain locations are hazardous because the atmosphere does or may contain a gas, vapor, or dust in explosive quantities. For a complete list of explosive agents refer to section 500 of the National Electrical Code.
2. The use of a UL Listed motor on a fan does not necessarily make an installation spark proof or explosion proof. Consult the local building codes, OSHA, NEC, or insurance company inspectors for detailed information as to proper procedures.

### Maintenance

1. Provide the end user of the fan with a copy of the fan manufacturer's operating instructions and safety information.
2. Whenever practical, post a warning sign indicating possible hazards. An example could be: "Make certain the power source is disconnected before attempting to service or disassemble any fan component." An alternate example could be: "Guard all moving parts, don't remove guards while the fan is in operation."

## Basic Fan Laws

Fan laws apply to all axial and centrifugal fans. They are used to determine fan performance when the fan speed (wheel RPM) is changed. These relationships apply only when there are no other changes to the fan system such as fan size, duct system, filters, air temperature or fan guards and screens. The three basic fan laws are listed below.

- A. Fan air delivery will vary directly as the RPM ratio.

$$\text{NEW CFM} = \frac{(\text{NEW RPM})}{(\text{OLD RPM})} \times \text{OLD CFM}$$

- B. Fan pressure will vary as the RPM ratio squared.

$$\text{NEW SP} = \left( \frac{(\text{NEW RPM})}{(\text{OLD RPM})} \right)^2 \times \text{OLD SP}$$

- C. Break horsepower load of the fan motor will vary as the RPM ratio cubed.

$$\text{NEW BHP} = \left( \frac{(\text{NEW RPM})}{(\text{OLD RPM})} \right)^3 \times \text{OLD BHP}$$

### Example 1:

A fan installed in an existing system produces 1000 CFM working against 2" static pressure (2" SP). This belt-driven fan is running at 250 RPM and driven by a fully loaded 1-HP motor. The fan is required to increase its speed to 300 RPM. This is an increase of 20% or 1.2 times faster. Determine the fan performance using the basic fan laws.

#### Solution 1:

- A. Because the fan speed varies directly with CFM, the new CFM will also increase 1.2 times.

$$\text{NEW CFM} = \frac{\text{NEW RPM (300)}}{\text{OLD RPM (250)}} \times \text{OLD CFM (1000)}$$

$$\text{NEW CFM} = 1.2 \times 1000$$

$$\text{NEW CFM} = 1200$$

NOTE: When a change in CFM is known, the new fan RPM may be calculated from the above formula by substituting RPM for CFM. See below.

$$\text{NEW RPM} = \frac{\text{NEW CFM}}{\text{OLD CFM}} \times \text{OLD RPM}$$

- B. More air flow in the system creates more duct friction and air turbulence. Static pressure will change by the square of the RPM ratio.

$$\text{NEW STATIC PRESSURE} = \left( \frac{(\text{NEW RPM (300)})}{(\text{OLD RPM (250)})} \right)^2 \times \text{OLD SP (2 in.)}$$

$$\text{NEW STATIC PRESSURE} = 1.2^2 \times 2 \text{ in.}$$

$$\text{NEW STATIC PRESSURE} = 1.44 \times 2 \text{ in.}$$

$$\text{NEW STATIC PRESSURE} = 2.88 \text{ in.}$$

NOTE: A 2 HP motor would be required.

- C. More air flow will greatly increase the fan's horsepower requirements. BHP will change by the cube of the RPM ratio.

$$\text{NEW BHP} = \left( \frac{(\text{NEW RPM (300)})}{(\text{OLD RPM (250)})} \right)^3 \times \text{OLD BHP (1.0)}$$

$$\text{NEW BHP} = 1.2^3 \times 1.0 \text{ BHP}$$

$$\text{NEW BHP} = 1.73 \times 1.0 \text{ BHP}$$

$$\text{NEW BHP} = 1.73$$

## Basic Fan Laws (Cont.)

### Example 2:

Same data as in Example 1, except the fan RPM is reduced by 20% or is 0.8 times the old RPM.

### Solution 2:

Use the basic fan laws to determine the new fan performance of 200 RPM, 800 CFM, 1.28 in SP and 0.512 BHP.

NOTE: Care must be taken when changing speeds on belt-driven fans, especially if they are to increase. A number of circumstances could occur: (1) the fan blade or wheel may not be designed to run at faster speeds; (2) maximum bearing speeds may be exceeded; (3) larger frame size motors may not fit on the existing fan; (4) available power source, wire cable size, fuse boxes and controls may not be compatible with a larger horsepower motor; (5) more air volume and higher fan speeds increase the noise level of the system; and (6) a change in fan speed can change its frequency resulting in vibration.

As a general rule, select a belt-driven fan with a larger air flow capacity than required. It is easier to slow down a fan by changing the pulleys to reduce air flow than to increase the fan speed.

Direct-driven fans have a lower initial cost than belt-driven fans but lack the flexibility of multiple speeds. Where additional air flow is required by increasing the fan/motor speed of a direct-driven fan, the same information applies as mentioned above. Direct-driven fans are generally not designed to accommodate multiple frame size motors. Additional care must be taken when selecting direct-driven fans.

Disclaimer: Dayton Electric Manufacturing Co. has made a diligent effort to illustrate and describe the products in this literature accurately; however, such illustrations and descriptions are for the sole purpose of identification, and do not express or imply a warranty that the products are merchantable, or fit for a particular purpose, or that the products will necessarily conform to the illustrations or descriptions.

Product Suitability: Many states and localities have codes and regulations governing sales, construction, installation, and/or use of products for certain purposes, which may vary from those in neighboring areas. While Dayton attempts to assure that its products comply with such codes, it cannot guarantee compliance, and cannot be responsible for how the product is installed or used. Before purchase and use of a product, please review the product application, and national and local codes and regulations, and be sure that the product, installation, and use will comply with them.